



SLIDING PATIO & FRENCH DOORS

Technical Guide J

FEATURES & SPECIFICATIONS

Styles

Operating/Fixed (XO or OX), Operating/Fixed/Operating (XOX), Fixed/Operating/Operating/Fixed (OXXO), Sliding Patio and French Patio options. See your Authorized Loewen Dealer for the full range of configurations.

Standard Features

Natural Douglas Fir interior (no visible finger joints)

4 9/16" (116 mm) and 6 9/16" (166 mm) jamb construction

LowE insulated tempered glazing

2 1/4" (58 mm) thick sliding panels

Interior/Exterior multipoint handle in Bright Brass

Extruded aluminum cladding in a variety of standard colors, primed wood or clear Fir exterior

Extruded aluminum-frame insect screen with high transparency mesh option

Hardware

Multiple hardware type and finish choices are available, see the hardware in section A for more information. Anti-lift security feature is standard. Security foot lock is optional. Multi-point locking hardware, complete with brass handle set and escutcheon is available. The locking hardware is also available in several optional finishes. Stainless steel rollers are optional.

Glazing

LowE Double, LowE Triple, Tranquility® and StormForce™. StormForce is not available on all products. Double or triple glass configurations with 1/2" (13 mm) airspace. With countless glazing configurations and LowE coating options, we ensure that you can choose the perfect blend of protection and comfort. LowE best describes the benefits of the product that incorporates glazing coatings and Argon gas. LowE systems help reduce heating and cooling costs, providing superior energy efficiency.

Simulated Divided Lites (SDL)

Standard SDL complete with airspace grilles, where available. Grille bars are permanently applied to the interior and exterior.

Ogee Profile – 3/4" (19 mm), 1 1/8" (30 mm), 2" (51 mm)

Putty Profile – 5/8" (16 mm), 7/8" (22 mm), 1 1/8" (30 mm), 2" (51 mm)

Square Profile (interior only) – 5/8" (16mm), 3/4" (19 mm), 7/8" (22 mm), 1 1/8" (30 mm), 2" (51 mm)

Casing

Wood: 2" (51 mm) Brickmould, 3 1/2" (89 mm) Flat, 5 1/2" (139 mm) Flat, Adams and Williamsburg.

Metal Clad: 2" (51 mm) Brickmould, 3 1/2" (89 mm) Flat, 2" clad frame extension, Nose & Cove, Adams, Williamsburg and Kerf.

FEATURES & SPECIFICATIONS

Metal Cladding

Heavy duty exterior metal cladding comprised of extruded aluminum is available in a variety of Palette colors, including anodized and Cyprium (copper and bronze cladding). Metal clad units are supplied ready-to-install complete with integral metal nailing flange.

Wood

In addition to our standard Coastal Douglas Fir, the entire Loewen product line is also available in optional Mahogany. The interior can be natural wood (unfinished), primed, or prefinished in Jet Black or Oxford White paint. Additional wood species, as well as the Jet Black and Oxford White prefinishes, are available through our Custom Shop. All door panels are constructed with a laminated engineered core of Douglas Fir. Alternate species are a thick skin applied over the engineered Douglas Fir core. All wood parts are dipped in approved preservative.

Performance Standards

Most units have been tested by an independent laboratory for air and water infiltration, structural performance, and thermal performance requirements.

Frame & Panel

Manufactured from Coastal Douglas Fir kiln-dried lumber with frame construction designed for 4 9/16" (116 mm) and 6 9/16" (166 mm) jamb. Opening panel is equipped with two sets of adjustable ball bearing tandem rollers. Sash is 2 1/4" (57 mm) thick for extra strength and durability. All wood exterior components are factory primed unless specified as clear exterior. Minor scratches or abrasions in the wood surface or primer are not considered defects.

Sill Track

Extruded metal sill with stainless steel cap over operating track for ease of operation and long-lasting performance. A dual sill block system with double drainage holes keep water out of the interior trough.

Weatherstrip

The combination of multiple weatherstrips ensure maximum protection against air and water infiltration.

Screen

Wood extruded units are available with extruded aluminum screen frame in bronze or white, with antiglare fiberglass screen cloth. Screen frame color is matched to exterior color on metal clad units. Screen is equipped with adjustable rollers on top and bottom to assure ease of operation and accurate fitting. Stainless steel components available.

Sidelites

Sidelites consist of a patio door panel and frame to match patio door. Supplied as a single unit with brickmould or nailing flange, or can be attached to patio doors.

Hardware Styles	Patio	French Patio
Multi-point Handle	●	●
Botticelli	●	●
Fontana	●	●

Hardware Styles	Patio	French Patio
Flush Handle	○	○
Miami	○	○
Churchill	○	○

Standard ● Optional ○

Variables	Patio	French Patio
Function		
Use for Egress	●	●
Available with Screen	●	●
Multi-point Hardware	●	●
Performance		
LowE Double	●	●
LowE Triple	○	○
StormForce™	○	○
Appearance		
SDL	○	○
Vertical Grain Fir Panel	●	●

Standard ● Optional ○



Patio

Visit the Loewen Photo Gallery online at www.loewen.com for a large collection of Loewen product and elevation photography.

Numerous custom window configuration opportunities exist – please contact your Authorized Loewen Dealer.

Specifications and technical information are subject to change without notice. Imperial and metric measurements are converted accurately. However, in some cases, industry standards cause a 1 mm variance. (Example: 3/4" is shown as 19 mm for all glass measurements.) Cad Download: www.loewen.com/architect | Installation Instructions: www.loewen.com

**Patio Door And Transom
2 Wide Door Sizes**

			Width		
Rough Opening			59 13/16 [1519]	71 5/8 [1819]	95 1/4 [2419]
	Frame		59 1/16 [1500]	70 7/8 [1800]	94 1/2 [2400]
	Visible Glass		24 1/8 [612]	30 [762]	41 13/16 [1062]
			TRANSOM		
16 1/2 [419]	15 3/4 [400]	10 1/2 [266]	WPT2* 1504	WPT2* 1804	WPT2* 2404
24 3/8 [619]	23 5/8 [600]	18 3/8 [466]	WPT2* 1506	WPT2* 1806	WPT2* 2406
			DOOR		
80 1/8 [2035]	79 1/2 [2020]	70 1/2 [1790]	WP2 1520	WP2 1820	WP2 2420
81 7/8 [2080]	81 5/16 [2065]	72 1/4 [1835]	WP2 1568	WP2 1868	WP2 2468
83 1/4 [2115]	82 11/16 [2100]	73 5/8 [1870]	WP2 1521	WP2 1821	WP2 2421
86 9/16 [2199]	86 [2184]	76 15/16 [1954]	WP2 1570	WP2 1870	WP2 2470
95 1/16 [2415]	94 1/2 [2400]	85 7/16 [2170]	WP2 1524	WP2 1824	WP2 2424
98 [2489]	97 3/8 [2474]	88 3/8 [2244]	WP2 1580	WP2 1880	WP2 2480
			Product Code		

Glass Size = Visible Glass + 15/16" (24 mm)

Standard sizes Shown. Additional sizes may be available. Custom sizes can be ordered.

- Note:
- SDL/Grille patterns are dependent on SDL/Grille type and window size. Please verify SDL/Grille patterns before confirming your order.
 - O = Fixed, X = Operating
 - Transom units.

**Patio Door And Transom
4 Wide Door Sizes**

Width

Height

Rough Opening			117 5/8 [2987]	141 1/4 [3587]	188 7/16 [4787]			
			Frame			116 7/8 [2968]	140 1/2 [3568]	187 11/16 [4768]
			Visible Glass			24 1/8 [612]	30 [762]	41 13/16 [1062]
			TRANSOM					
16 1/2 [419]	15 3/4 [400]	10 1/2 [266]	WPT4* 3004	WPT4* 3604	WPT4* 4804			
24 3/8 [619]	23 5/8 [600]	18 3/8 [466]	WPT4* 3006	WPT4* 3606	WPT4* 4806			
			DOOR					
80 1/8 [2035]	79 1/2 [2020]	70 1/2 [1790]	WP4 3020	WP4 3620	WP4 4820			
81 7/8 [2080]	81 5/16 [2065]	72 1/4 [1835]	WP4 3068	WP4 3668	WP4 4868			
83 1/4 [2115]	82 11/16 [2100]	73 5/8 [1870]	WP4 3021	WP4 3621	WP4 4821			
86 9/16 [2199]	86 [2184]	76 15/16 [1954]	WP4 3070	WP4 3670	WP4 4870			
95 1/16 [2415]	94 1/2 [2400]	85 7/16 [2170]	WP4 3024	WP4 3624	WP4 4824			
98 [2489]	97 3/8 [2474]	88 3/8 [2244]	WP4 3080	WP4 3680	WP4 4880			

Product Code

Glass Size = Visible Glass + 15/16" (24 mm)

Standard sizes Shown. Additional sizes may be available. Custom sizes can be ordered.

- Note:
- SDL/Grille patterns are dependent on SDL/Grille type and window size. Please verify SDL/Grille patterns before confirming your order.
 - O = Fixed, X = Operating
 - Transom units.

**Patio Door And Transom
Fixed Sidelite Door Sizes**

			Width		
Rough Opening			32 1/4 [819]	38 1/8 [969]	49 15/16 [1269]
	Frame		31 1/2 [800]	37 3/8 [950]	49 3/16 [1250]
	Visible Glass		24 1/8 [612]	30 [762]	41 13/16 [1062]
			TRANSOM		
16 1/2 [419]	15 3/4 [400]	10 1/2 [266]	WPT1* 7504	WPT1* 0904	WPT1* 1204
24 3/8 [619]	23 5/8 [600]	18 3/8 [466]	WPT1* 7506	WPT1* 0906	WPT1* 1206
			DOOR		
80 1/8 [2035]	79 1/2 [2020]	70 1/2 [1790]	WP1 7520	WP1 0920	WP1 1220
81 7/8 [2080]	81 5/16 [2065]	72 1/4 [1835]	WP1 7568	WP1 0968	WP1 1268
83 1/4 [2115]	82 11/16 [2100]	73 5/8 [1870]	WP1 7521	WP1 0921	WP1 1221
86 9/16 [2199]	86 [2184]	76 15/16 [1954]	WP1 7570	WP1 0970	WP1 1270
95 1/16 [2415]	94 1/2 [2400]	85 7/16 [2170]	WP1 7524	WP1 0924	WP1 1224
98 [2489]	97 3/8 [2474]	88 3/8 [2244]	WP1 7580	WP1 0980	WP1 1280
			Product Code		

Glass Size = Visible Glass + 15/16" (24 mm)

Standard sizes Shown. Additional sizes may be available. Custom sizes can be ordered.

- Note:
- SDL/Grille patterns are dependent on SDL/Grille type and window size. Please verify SDL/Grille patterns before confirming your order.
 - Transom units.

**Patio Door And Transom
3 Wide Door Sizes**

Width

Height

Rough Opening			117 5/8 [2987]	141 1/4 [3587]	160 13/16 [4085]	172 11/16 [4386]
Frame			116 7/8 [2968]	140 1/2 [3568]	160 1/16 [4066]	171 15/16 [4367]
Visible Glass			24 1/8 - 54 3/16 - 24 1/8 [612 - 1376 - 612]	30 - 66 - 30 [762 - 1676 - 762]	41 13/16 - 61 15/16 - 41 13/16 [1062 - 1574 - 1062]	41 13/16 - 73 13/16 - 41 13/16 [1062 - 1875 - 1062]
			TRANSOM			
16 1/2 [419]	15 3/4 [400]	10 1/2 [266]	WPT3* 3004	WPT3* 3604	WPT3* 4104	WPT3* 4404
24 3/8 [619]	23 5/8 [600]	18 3/8 [466]	WPT3* 3006	WPT3* 3606	WPT3* 4106	WPT3* 4406
			DOOR			
80 1/8 [2035]	79 1/2 [2020]	70 1/2 [1790]	WP3 3020	WP3 3620	WP3 4120	WP3 4420
81 7/8 [2080]	81 5/16 [2065]	72 1/4 [1835]	WP3 3068	WP3 3668	WP3 4168	WP3 4468
83 1/4 [2115]	82 11/16 [2100]	73 5/8 [1870]	WP3 3021	WP3 3621	WP3 4121	WP3 4421
86 9/16 [2199]	86 [2184]	76 15/16 [1954]	WP3 3070	WP3 3670	WP3 4170	WP3 4470
95 1/16 [2415]	94 1/2 [2400]	85 7/16 [2170]	WP3 3024	WP3 3624	WP3 4124	WP3 4424
98 [2489]	97 3/8 [2474]	88 3/8" 2244	WP3 3080	WP3 3680	WP3 4180	WP3 4480

Product Code

Glass Size = Visible Glass + 15/16" (24 mm)

Standard sizes Shown. Additional sizes may be available. Custom sizes can be ordered.

- Note:
- SDL/Grille patterns are dependent on SDL/Grille type and window size. Please verify SDL/Grille patterns before confirming your order.
 - O = Fixed, X = Operating
 - Transom units.

**Patio Door And Transom
Fixed Sidelite Door Sizes**

Width

Rough Opening				32 1/4 [819]	38 1/8 [969]	49 15/16 [1269]	
			Frame		31 1/2 [800]	37 3/8 [950]	49 3/16 [1250]
				Visible Glass	24 1/8 [612]	30 [762]	41 13/16 [1062]
			TRANSOM				
16 1/2 [419]	15 3/4 [400]	10 1/2 [266]	WPT1* 7504	WPT1* 0904	WPT1* 1204		
24 3/8 [619]	23 5/8 [600]	18 3/8 [466]	WPT1* 7506	WPT1* 0906	WPT1* 1206		
			DOOR				
80 1/8 [2035]	79 1/2 [2020]	70 1/2 [1790]	WP1 7520	WP1 0920	WP1 1220		
81 7/8 [2080]	81 5/16 [2065]	72 1/4 [1835]	WP1 7568	WP1 0968	WP1 1268		
83 1/4 [2115]	82 11/16 [2100]	73 5/8 [1870]	WP1 7521	WP1 0921	WP1 1221		
86 9/16 [2199]	86 [2184]	76 15/16 [1954]	WP1 7570	WP1 0970	WP1 1270		
95 1/16 [2415]	94 1/2 [2400]	85 7/16 [2170]	WP1 7524	WP1 0924	WP1 1224		
98 [2489]	97 3/8 [2474]	88 3/8 [2244]	WP1 7580	WP1 0980	WP1 1280		
			Product Code				

Height

Glass Size = Visible Glass + 15/16" (24 mm)

Standard sizes Shown. Additional sizes may be available. Custom sizes can be ordered.

- Note:
- SDL/Grille patterns are dependent on SDL/Grille type and window size. Please verify SDL/Grille patterns before confirming your order.
 - Transom units.

**Patio Door And Transom
3 Wide Door Sizes**

Width

Height

Rough Opening			117 5/8 [2987]	141 1/4 [3587]	160 13/16 [4085]	172 11/16 [4386]
Frame			116 7/8 [2968]	140 1/2 [3568]	160 1/16 [4066]	171 15/16 [4367]
Visible Glass			24 1/8 - 54 3/16 - 24 1/8 [612 - 1376 - 612]	30 - 66 - 30 [762 - 1676 - 762]	41 13/16 - 61 15/16 - 41 13/16 [1062 - 1574 - 1062]	41 13/16 - 73 13/16 - 41 13/16 [1062 - 1875 - 1062]
			TRANSOM			
16 1/2 [419]	15 3/4 [400]	10 1/2 [266]	WPT3* 3004	WPT3* 3604	WPT3* 4104	WPT3* 4404
24 3/8 [619]	23 5/8 [600]	18 3/8 [466]	WPT3* 3006	WPT3* 3606	WPT3* 4106	WPT3* 4406
			DOOR			
80 1/8 [2035]	79 1/2 [2020]	70 1/2 [1790]	WP3 3020	WP3 3620	WP3 4120	WP3 4420
81 7/8 [2080]	81 5/16 [2065]	72 1/4 [1835]	WP3 3068	WP3 3668	WP3 4168	WP3 4468
83 1/4 [2115]	82 11/16 [2100]	73 5/8 [1870]	WP3 3021	WP3 3621	WP3 4121	WP3 4421
86 9/16 [2199]	86 [2184]	76 15/16 [1954]	WP3 3070	WP3 3670	WP3 4170	WP3 4470
95 1/16 [2415]	94 1/2 [2400]	85 7/16 [2170]	WP3 3024	WP3 3624	WP3 4124	WP3 4424
98 [2489]	97 3/8 [2474]	88 3/8" 2244	WP3 3080	WP3 3680	WP3 4180	WP3 4480

Product Code

Glass Size = Visible Glass + 15/16" (24 mm)

Standard sizes Shown. Additional sizes may be available. Custom sizes can be ordered.

- Note:
- SDL/Grille patterns are dependent on SDL/Grille type and window size. Please verify SDL/Grille patterns before confirming your order.
 - O = Fixed, X = Operating
 - Transom units.

Patio Door Detail

Head & Sill Detail

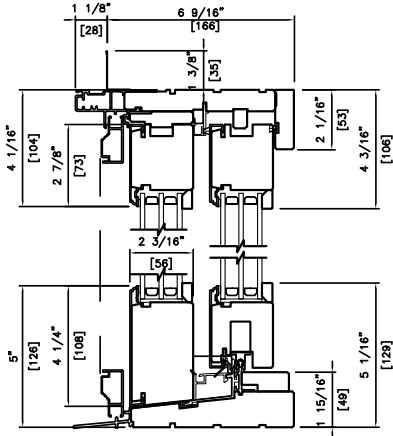

METAL CLAD TRIPLE
6 9/16" (166mm)

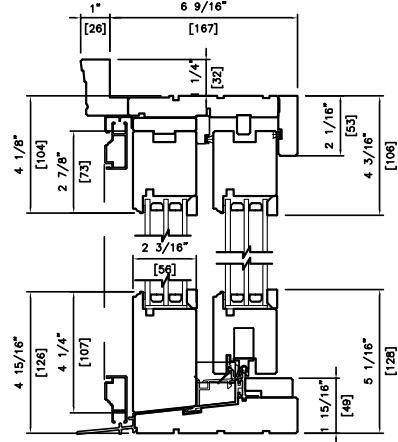

WOOD EXTERIOR TRIPLE
6 9/16" (166mm)
2" BRICKMOULD

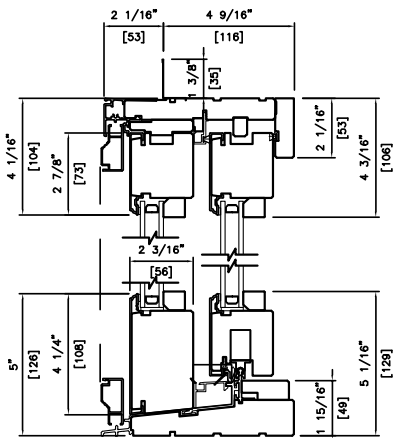

METAL CLAD DOUBLE
4 9/16" (116mm)

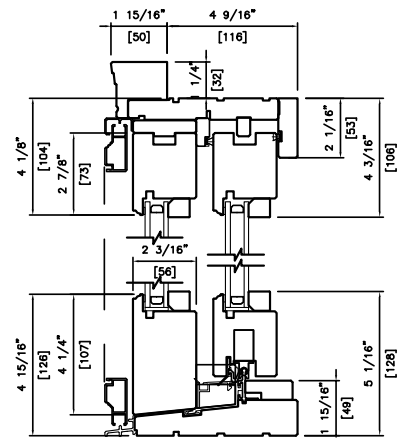

WOOD EXTERIOR DOUBLE
4 9/16" (116mm)
2" BRICKMOULD

Note:

- Other jamb widths available.
- All dimensions to have +/- 1/16" (2mm) tolerance.

**Patio Door
Detail**

Plan View

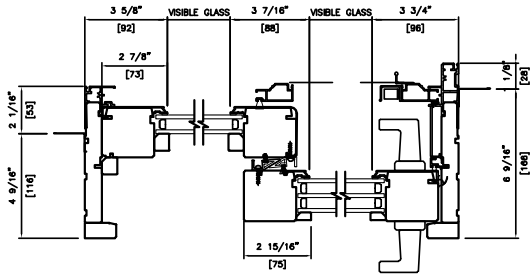

METAL CLAD DOUBLE/TRIPLE
4 9/16" (116mm)/6 9/16" (166mm)

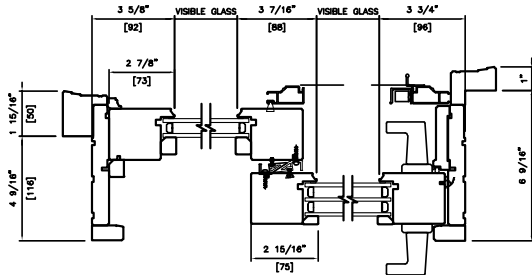

WOOD EXTERIOR DOUBLE/TRIPLE
4 9/16" (116mm)/6 9/16" (166mm)
2" BRICKMOULD

Head & Sill Detail

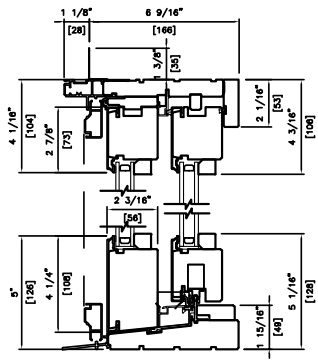

METAL CLAD DOUBLE
6 9/16" (166mm)

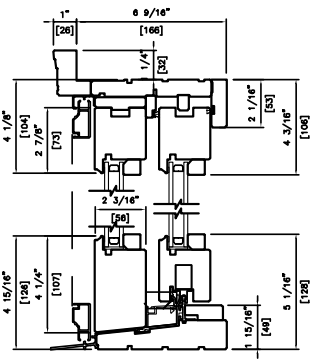

WOOD EXTERIOR DOUBLE
6 9/16" (166mm)
2" BRICKMOULD

Note: • Other jamb widths available.
• All dimensions to have +/- 1/16" (2mm) tolerance.

Patio Door Detail

Plan View

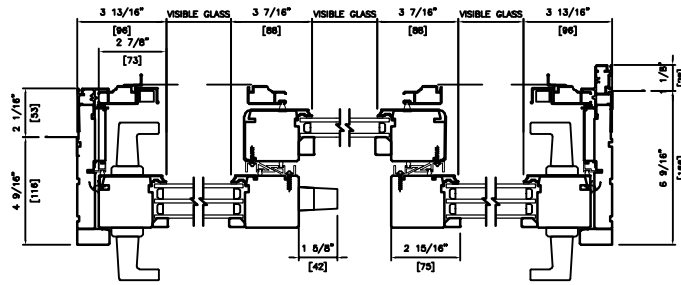

METAL CLAD TRIPLE/DOUBLE/TRIPLE
THREE PANEL
4 9/16" (116mm)/6 9/16" (166mm)

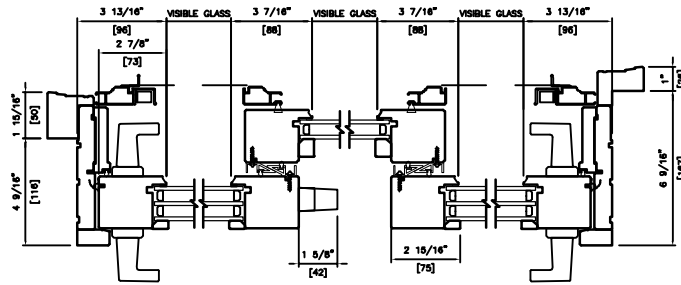

WOOD EXTERIOR TRIPLE/DOUBLE/TRIPLE
THREE PANEL
4 9/16" (116mm)/6 9/16" (166mm)
2" BRICKMOULD

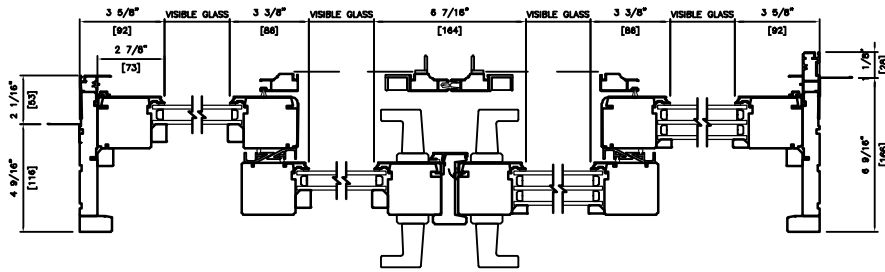

METAL CLAD DOUBLE/DOUBLE/TRIPLE/TRIPLE
FOUR PANEL
4 9/16" (116mm)/6 9/16" (166mm)

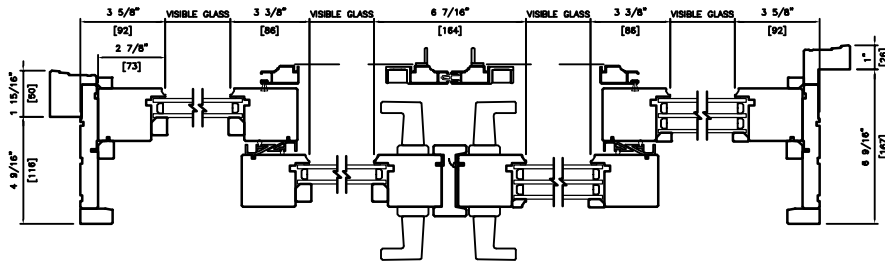

WOOD EXTERIOR DOUBLE/DOUBLE/TRIPLE/TRIPLE
FOUR PANEL
4 9/16" (116mm)/6 9/16" (166mm)
2" BRICKMOULD

Note: • Other jamb widths available.
• All dimensions to have +/- 1/16" (2mm) tolerance.

Patio Door Sidelite Detail

Plan View

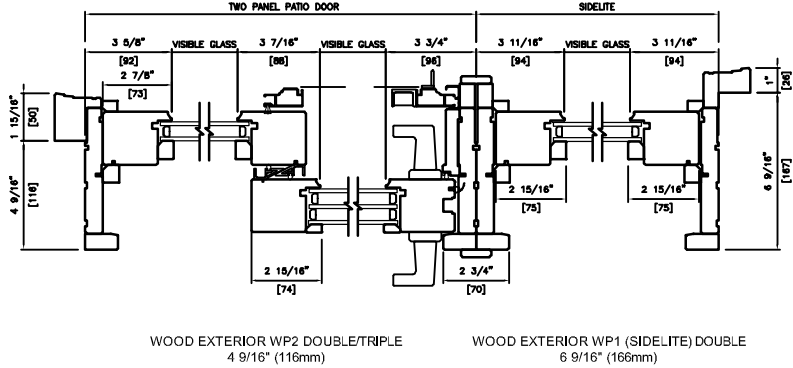
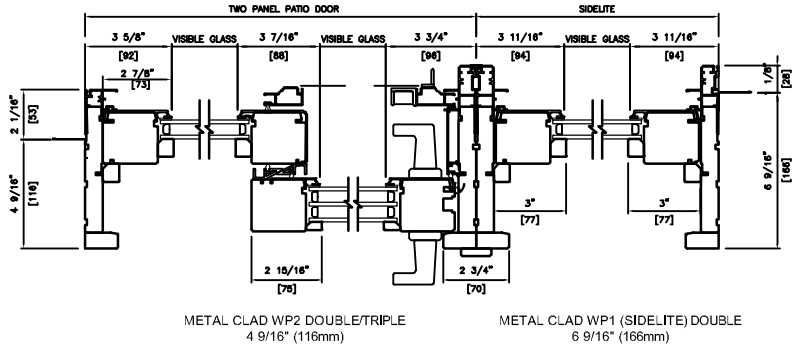

Head & Sill Detail

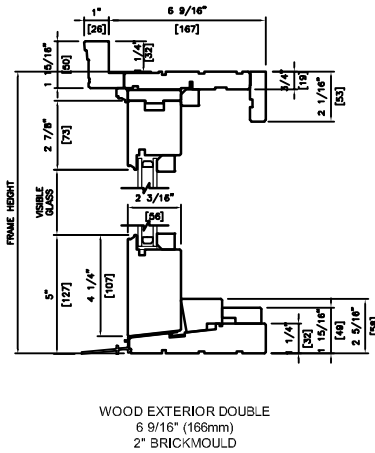
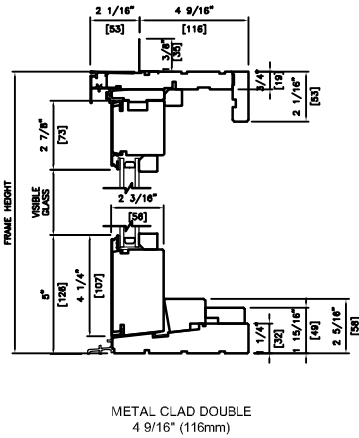

Note: • Other jamb widths available.
• All dimensions to have +/- 1/16" (2mm) tolerance.

Patio Door Transom Detail

Head & Sill Detail

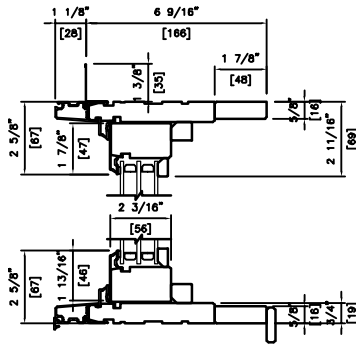

METAL CLAD TRIPLE
6 9/16" (166mm)

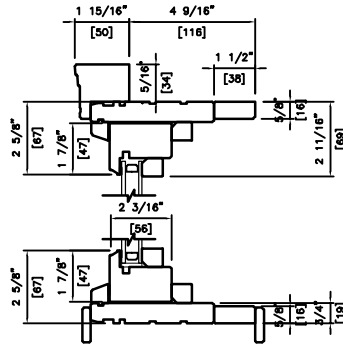

WOOD EXTERIOR DOUBLE
4 9/16" (116mm)
2" BRICKMOULD

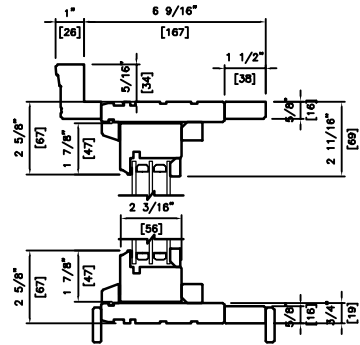

WOOD EXTERIOR TRIPLE
6 9/16" (166mm)
2" BRICKMOULD

Head & Sill Detail

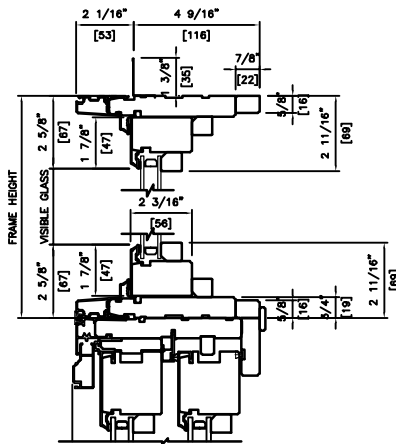

METAL CLAD DOUBLE
4 9/16" (116mm)

Plan View

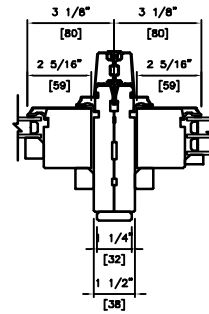

METAL CLAD DOUBLE/TRIPLE

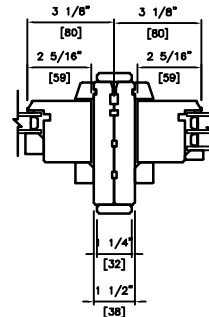

WOOD EXTERIOR DOUBLE/TRIPLE

Note: • Other jamb widths available.
• All dimensions to have +/- 1/16" (2mm) tolerance.

**Patio Door Transom
Detail**

Plan View

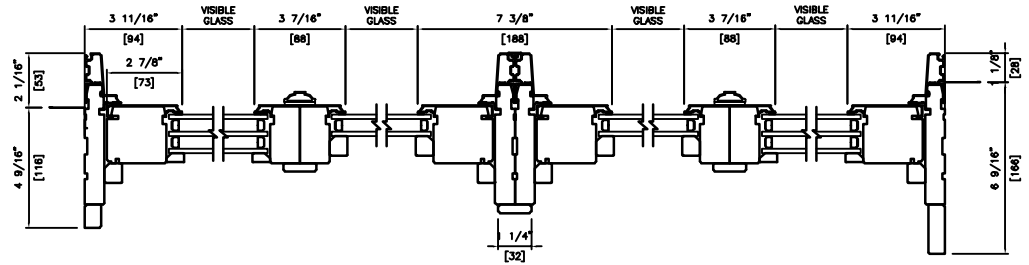

METAL CLAD TRIPLE/DOUBLE/DOUBLE/TRIPLE
FOUR PANEL
4 9/16" (116mm)/6 9/16" (166mm)

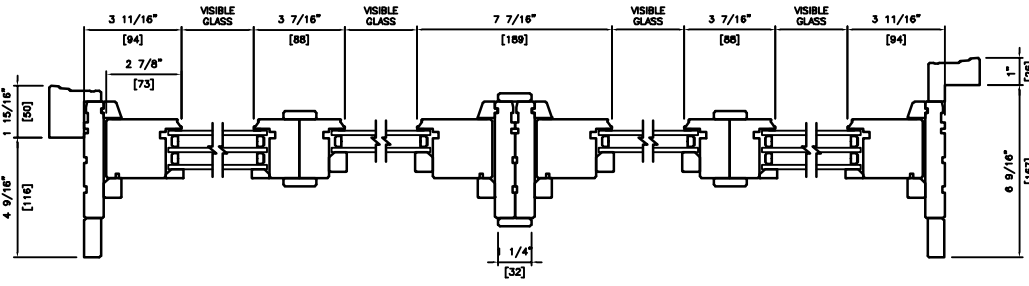

WOOD EXTERIOR TRIPLE/DOUBLE/DOUBLE/TRIPLE
FOUR PANEL
4 9/16" (116mm)/6 9/16" (166mm)
2" BRICKMOULD

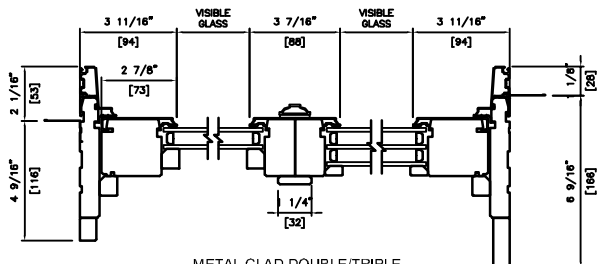

METAL CLAD DOUBLE/TRIPLE
TWO PANEL
4 9/16" (116mm)/6 9/16" (166mm)

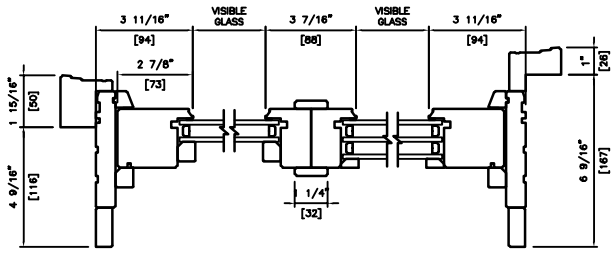

WOOD EXTERIOR DOUBLE/TRIPLE
TWO PANEL
4 9/16" (116mm)/6 9/16" (166mm)
2" BRICKMOULD

Note: • Other jamb widths available.
• All dimensions to have +/- 1/16" (2mm) tolerance.

French Patio Door And Transom 2 Wide Door Sizes

Rough Opening			Width			
			59 13/16 [1519]	71 5/8 [1819]	95 1/4 [2419]	
Frame			59 1/16 [1500]	70 7/8 [1800]	94 1/2 [2400]	
Visible Glass			21 13/16 [538]	27 1/16 [688]	38 7/8 [988]	
			TRANSOM			
Height	16 1/2 [419]	15 3/4 [400]	10 1/2 [266]	FPT2* 1504	FPT2* 1804	FPT2* 2404
	24 3/8 [619]	23 5/8 [600]	18 3/8 [466]	FPT2* 1506	FPT2* 1806	FPT2* 2406
			DOOR			
80 1/8 [2035]	79 1/2 [2020]	64 [1626]	FP2 1520	FP2 1820	FP2 2420	
81 7/8 [2080]	81 5/16 [2065]	65 13/16 [1671]	FP2 1568	FP2 1868	FP2 2468	
83 1/4 [2115]	82 11/16 [2100]	67 3/16 [1706]	FP2 1521	FP2 1821	FP2 2421	
86 9/16 [2199]	86 [2184]	70 1/2 [1790]	FP2 1570	FP2 1870	FP2 2470	
95 1/16 [2415]	94 1/2 [2400]	79 [2006]	FP2 1524	FP2 1824	FP2 2424	
98 [2489]	97 3/8 [2474]	81 7/8 [2080]	FP2 1580	FP2 1880	FP2 2480	
106 7/8 [2715]	106 5/16 [2700]	90 13/16 [2306]	FP2 1527	FP2 1827	FP2 2427	
			Product Code			

Glass Size = Visible Glass + 15/16" (24 mm)

Standard sizes Shown. Additional sizes may be available. Custom sizes can be ordered.

- Note:
- SDL/Grille patterns are dependent on SDL/Grille type and window size. Please verify SDL/Grille patterns before confirming your order.
 - O = Fixed, X = Operating
 - Transom units.

**French Patio Door And Transom
4 Wide Door Sizes**

			Width		
Rough Opening			117 5/8 [2987]	141 1/4 [3587]	188 7/16 [4787]
	Frame		116 7/8 [2968]	140 1/2 [3568]	187 11/16 [4768]
	Visible Glass		21 13/16 [538]	27 1/16 [688]	38 7/8 [988]
			TRANSOM		
16 1/2 [419]	15 3/4 [400]	10 1/2 [266]	FPT4* 3004	FPT4* 3604	FPT4* 4804
24 3/8 [619]	23 5/8 [600]	18 3/8 [466]	FPT4* 3006	FPT4* 3606	FPT4* 4806
			DOOR		
80 1/8 [2035]	79 1/2 [2020]	64 [1626]	FP4 3020	FP4 3620	FP4 4820
81 7/8 [2080]	81 5/16 [2065]	65 13/16 [1671]	FP4 3068	FP4 3668	FP4 4868
83 1/4 [2115]	82 11/16 [2100]	67 3/16 [1706]	FP4 3021	FP4 3621	FP4 4821
86 9/16 [2199]	86 [2184]	70 1/2 [1790]	FP4 3070	FP4 3670	FP4 4870
95 1/16 [2415]	94 1/2 [2400]	79 [2006]	FP4 3024	FP4 3624	FP4 4824
98 [2489]	97 3/8 [2474]	81 7/8 [2080]	FP4 3080	FP4 3680	FP4 4880
106 7/8 [2715]	106 5/16 [2700]	90 13/16 [2306]	FP4 3027	FP4 3627	FP4 4827
			Product Code		

Height

Glass Size = Visible Glass + 15/16" (24 mm)

Standard sizes Shown. Additional sizes may be available. Custom sizes can be ordered.

- Note:
- SDL/Grille patterns are dependent on SDL/Grille type and window size. Please verify SDL/Grille patterns before confirming your order.
 - O = Fixed, X = Operating
 - Transom units.

French Patio Door And Transom Fixed Sidelite Door Sizes

Rough Opening			Width		
			32 1/4 [819]	38 1/8 [969]	49 15/16 [1269]
Frame			31 1/2 [800]	37 3/8 [950]	49 3/16 [1250]
		Visible Glass	21 13/16 [538]	27 1/16 [688]	38 7/8 [988]
			TRANSOM		
16 1/2 [419]	15 3/4 [400]	10 1/2 [266]	FPT1* 7504	FPT1* 0904	FPT1* 1204
24 3/8 [619]	23 5/8 [600]	18 3/8 [466]	FPT1* 7506	FPT1* 0906	FPT1* 1206
			DOOR		
80 1/8 [2035]	79 1/2 [2020]	64 [1626]	FP1 7520	FP1 0920	FP1 1220
81 7/8 [2080]	81 5/16 [2065]	65 13/16 [1671]	FP1 7568	FP1 0968	FP1 1268
83 1/4 [2115]	82 11/16 [2100]	67 3/16 [1706]	FP1 7521	FP1 0921	FP1 1221
86 9/16 [2199]	86 [2184]	70 1/2 [1790]	FP1 7570	FP1 0970	FP1 1270
95 1/16 [2415]	94 1/2 [2400]	79 [2006]	FP1 7524	FP1 0924	FP1 1224
98 [2489]	97 3/8 [2474]	81 7/8 [2080]	FP1 7580	FP1 0980	FP1 1280
106 7/8 [2715]	106 5/16 [2700]	90 13/16 [2306]	FP1 7527	FP1 0927	FP1 1227

Height

Product Code

Glass Size = Visible Glass + 15/16" (24 mm)

Standard sizes Shown. Additional sizes may be available. Custom sizes can be ordered.

- Note:
- SDL/Grille patterns are dependent on SDL/Grille type and window size. Please verify SDL/Grille patterns before confirming your order.
 - Transom units.

**French Patio Door And Transom
3 Wide Door Sizes**

Width

Rough Opening			117 5/8 [2987]	141 1/4 [3587]	160 13/16 [4085]	172 11/16 [4386]
	Frame		116 7/8 [2968]	140 1/2 [3568]	160 1/16 [4066]	171 15/16 [4367]
		Visible Glass	21 3/16 - 51 1/4 - 21 3/16 [538 - 1302 - 538]	27 1/16 - 63 1/16 - 27 1/16 [688 - 1602 - 688]	38 7/8 - 59 1/16 - 38 7/8 [988 - 1500 - 988]	38 7/8 - 70 7/8 - 38 7/8 [988 - 1801 - 988]
			TRANSOM			
16 1/2 [419]	15 3/4 [400]	10 1/2 [266]	FPT3* 3004	FPT3* 3604	FPT3* 4104	FPT3* 4404
24 3/8 [619]	23 5/8 [600]	18 3/8 [466]	FPT3* 3006	FPT3* 3606	FPT3* 4106	FPT3* 4406
			DOOR			
80 1/8 [2035]	79 1/2 [2020]	64 [1626]	FP3 3020	FP3 3620	FP3 4120	FP3 4420
81 7/8 [2080]	81 5/16 [2065]	65 13/16 [1671]	FP3 3068	FP3 3668	FP3 4168	FP3 4468
83 1/4 [2115]	82 11/16 [2100]	67 3/16 [1706]	FP3 3021	FP3 3621	FP3 4121	FP3 4421
86 9/16 [2199]	86 [2184]	70 1/2 [1790]	FP3 3070	FP3 3670	FP3 4170	FP3 4470
95 1/16 [2415]	94 1/2 [2400]	79 [2006]	FP3 3024	FP3 3624	FP3 4124	FP3 4424
98 [2489]	97 3/8 [2474]	81 7/8 [2080]	FP3 3080	FP3 3680	FP3 4180	FP3 4480

Height

Product Code

Glass Size = Visible Glass + 15/16" (24 mm)

Standard sizes Shown. Additional sizes may be available. Custom sizes can be ordered.

- Note:
- SDL/Grille patterns are dependent on SDL/Grille type and window size. Please verify SDL/Grille patterns before confirming your order.
 - Transom units.

French Patio Door Detail

Head & Sill Detail

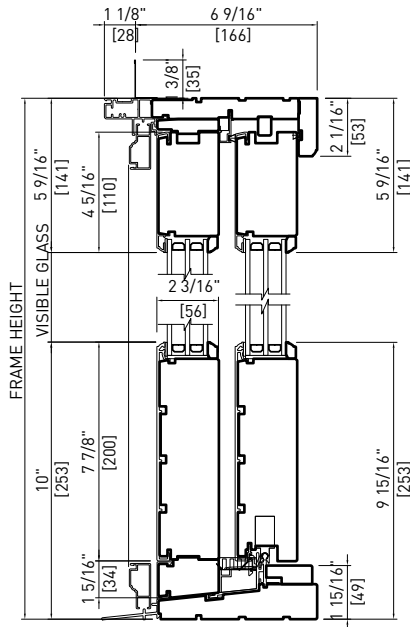

METAL CLAD TRIPLE
6 9/16" (166 mm)

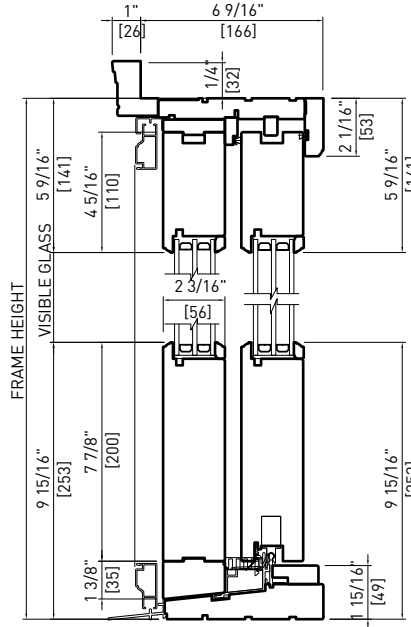

WOOD EXTERIOR TRIPLE
6 9/16" (166 mm)
2" BRICKMOULD

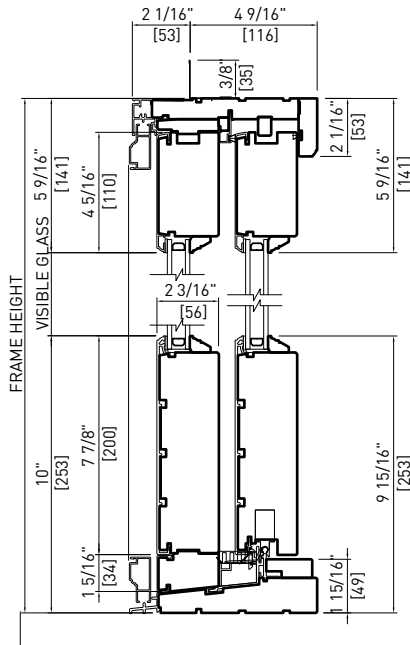

METAL CLAD TRIPLE
4 9/16" (116 mm)

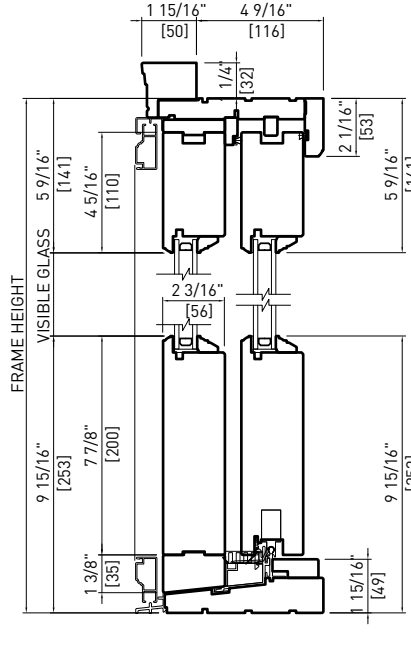

WOOD EXTERIOR TRIPLE
4 9/16" (116 mm)
2" BRICKMOULD

Note:

- Other jamb widths available.
- All dimensions to have +/- 1/16" (2mm) tolerance.

French Patio Door Detail

Plan View

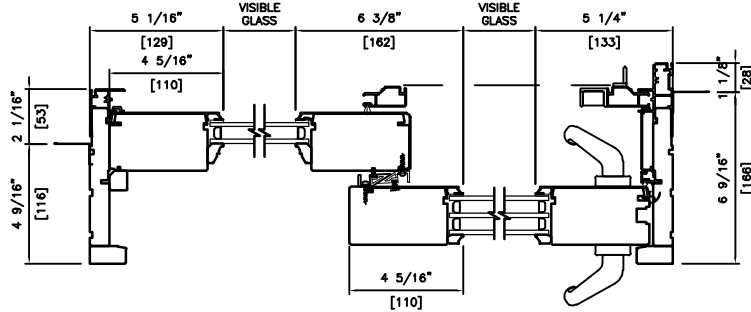

METAL CLAD DOUBLE/TRIPLE
4 9/16" (116mm)/6 9/16" (166mm)

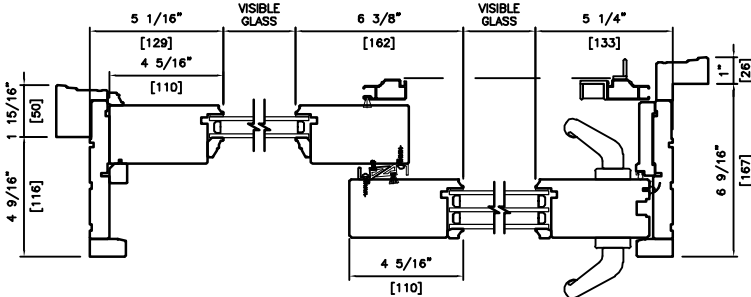

WOOD EXTERIOR DOUBLE/TRIPLE
4 9/16" (116mm)/6 9/16" (166mm)
2" BRICKMOULD

Head & Sill Detail

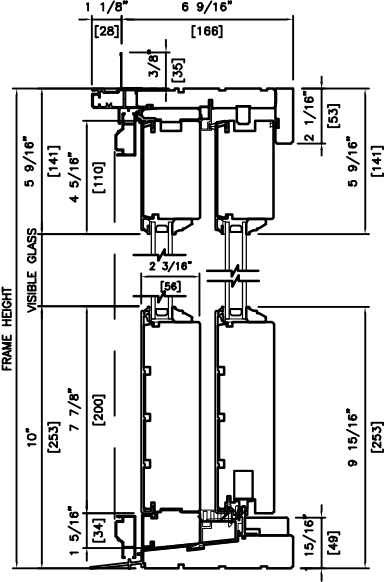

METAL CLAD DOUBLE
6 9/16" (166mm)

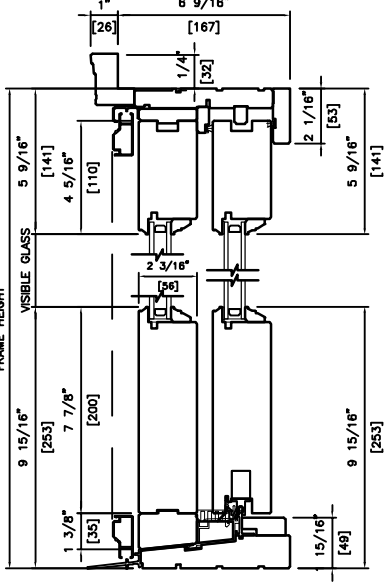

WOOD EXTERIOR DOUBLE
6 9/16" (166mm)
2" BRICKMOULD

Note: • Other jamb widths available.
• All dimensions to have +/- 1/16" (2mm) tolerance.

French Patio Door Detail

Plan View

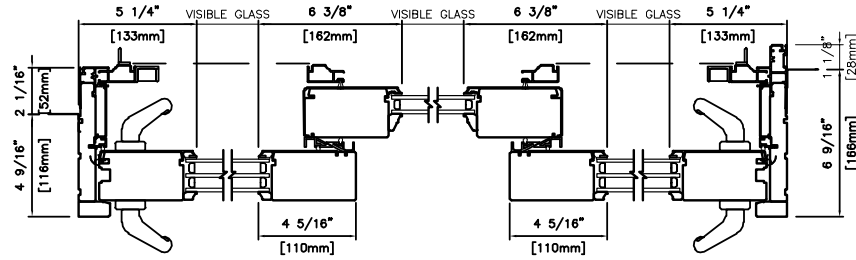

METAL CLAD TRIPLE/DOUBLE/TRIPLE
THREE PANEL
4 9/16" (116mm)/6 9/16" (166mm)

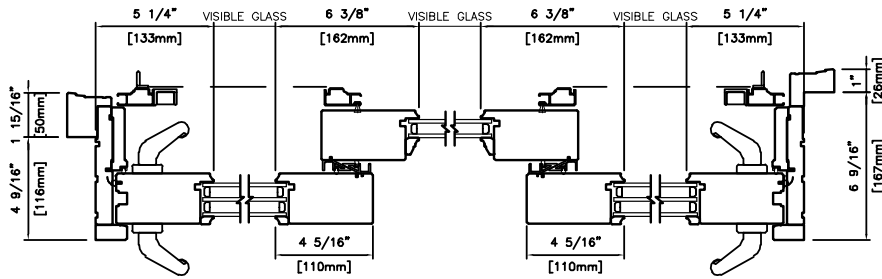

WOOD EXTERIOR TRIPLE/DOUBLE/TRIPLE
THREE PANEL
4 9/16" (116mm)/6 9/16" (166mm)
2" BRICKMOULD

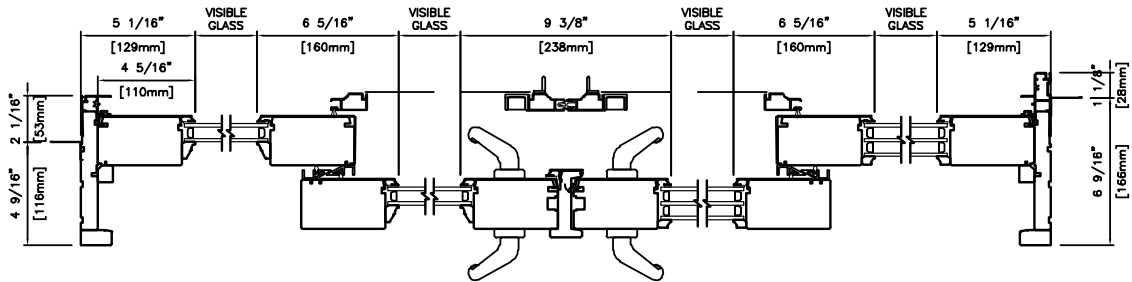

METAL CLAD DOUBLE/DOUBLE/TRIPLE/TRIPLE
FOUR PANEL
4 9/16" (116mm)/6 9/16" (166mm)

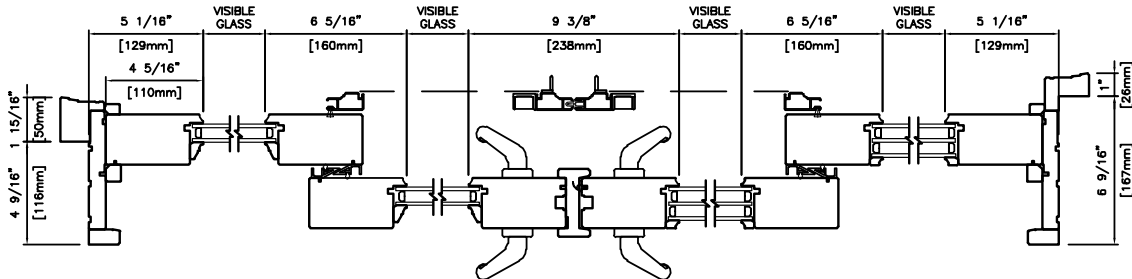

WOOD EXTERIOR DOUBLE/DOUBLE/TRIPLE/TRIPLE
FOUR PANEL
4 9/16" (116mm)/6 9/16" (166mm)
2" BRICKMOULD

Note: • Other jamb widths available.
• All dimensions to have +/- 1/16" (2mm) tolerance.

French Patio Door Sidelite Detail

Plan View

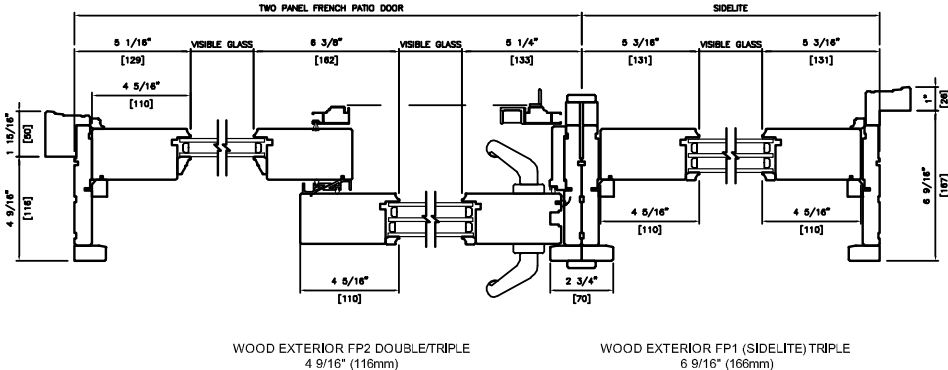
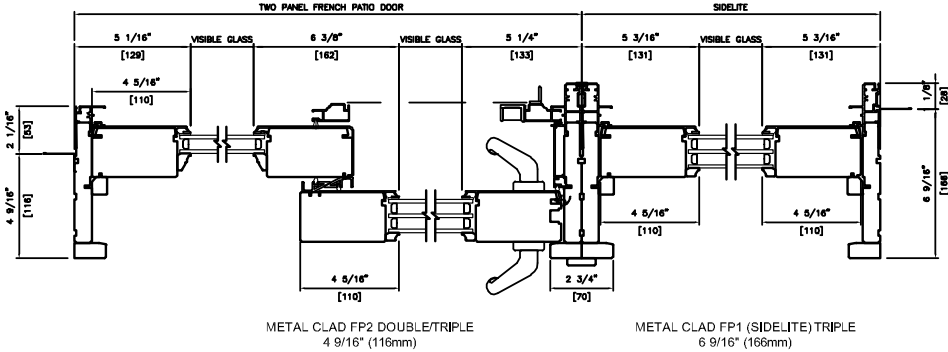

Head & Sill Detail

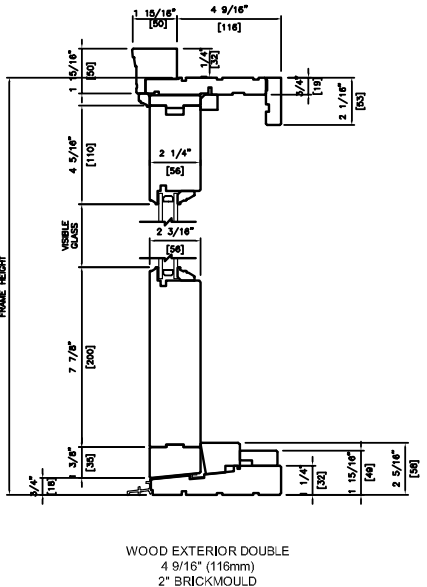
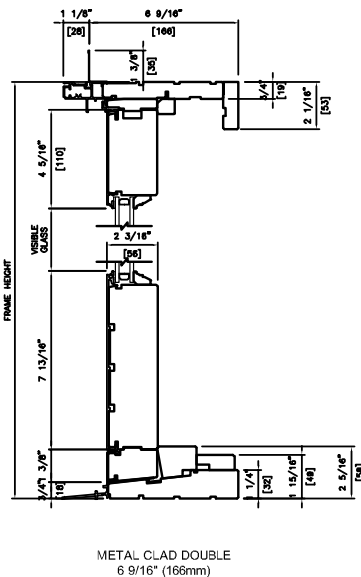

Note: • Other jamb widths available.
 • All dimensions to have +/- 1/16" (2mm) tolerance.

French Patio Door Transom Detail

Head & Sill Detail

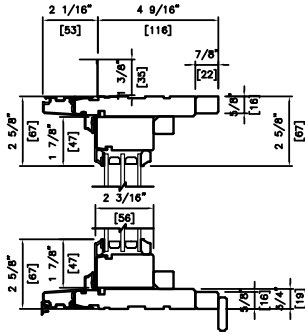

METAL CLAD TRIPLE
4 9/16" (116mm)

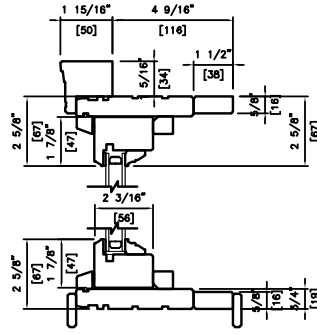

WOOD EXTERIOR DOUBLE
4 9/16" (116mm)
2" BRICKMOULD

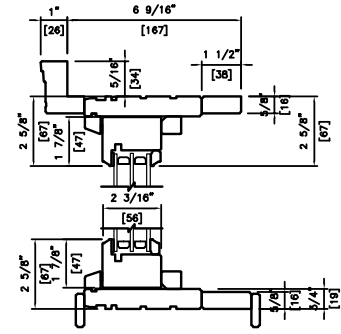

WOOD EXTERIOR TRIPLE
6 9/16" (166mm)
2" BRICKMOULD

Head & Sill Detail

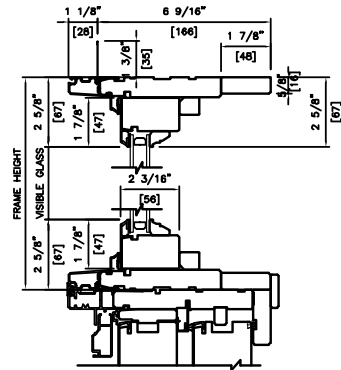

METAL CLAD DOUBLE
6 9/16" (166mm)

Plan View

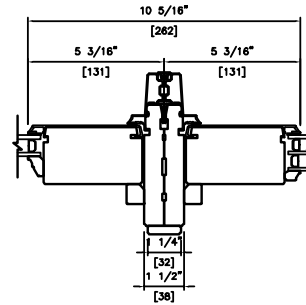

METAL CLAD
DOUBLE/TRIPLE

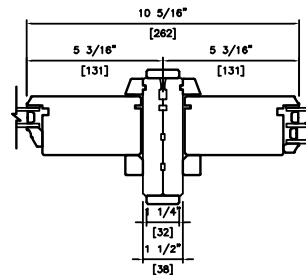

WOOD EXTERIOR
DOUBLE/TRIPLE

Note: • Other jamb widths available.
• All dimensions to have +/- 1/16" (2mm) tolerance.

French Patio Door Transom Detail

Plan View

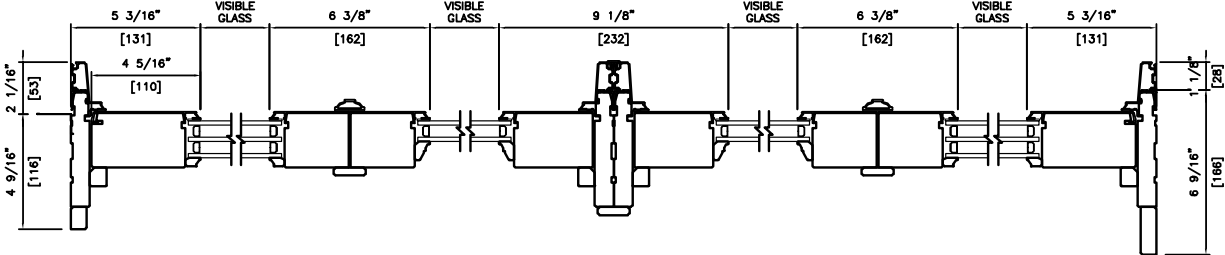

METAL CLAD
TRIPLE/DOUBLE/DOUBLE/TRIPLE
FOUR PANEL
4 9/16" (116mm)/6 9/16" (166mm)

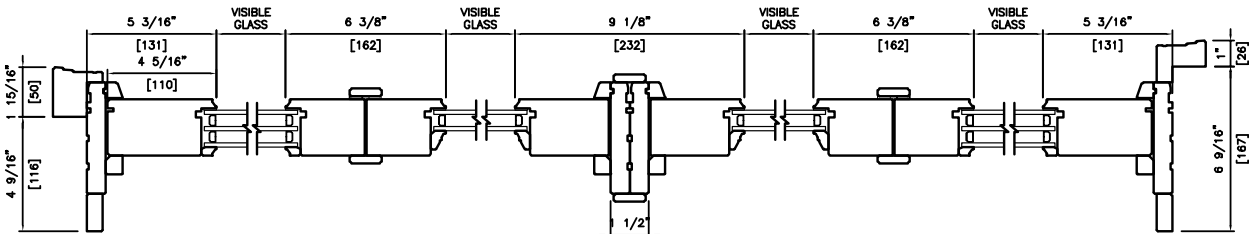

WOOD EXTERIOR
TRIPLE/DOUBLE/DOUBLE/TRIPLE
FOUR PANEL
4 9/16" (116mm)/6 9/16" (166mm)
2" BRICKMOULD

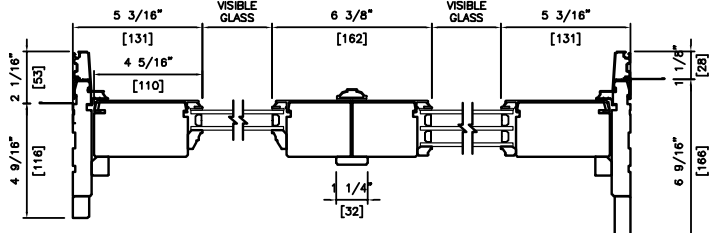

METAL CLAD DOUBLE/TRIPLE
TWO PANEL
4 9/16" (116mm)/6 9/16" (166mm)

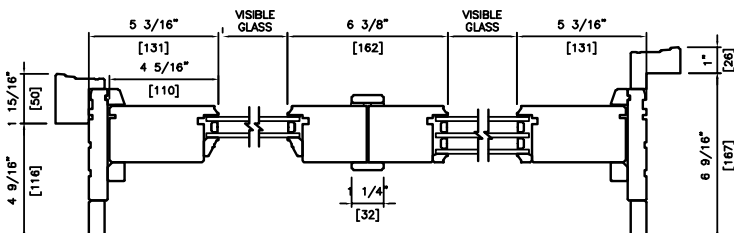

WOOD EXTERIOR DOUBLE/TRIPLE
TWO PANEL
4 9/16" (116mm)/6 9/16" (166mm)
2" BRICKMOULD

Note: • Other jamb widths available.
• All dimensions to have +/- 1/16" (2mm) tolerance.

